

GLOW

USER MANUAL & INSTALLATION INSTRUCTIONS

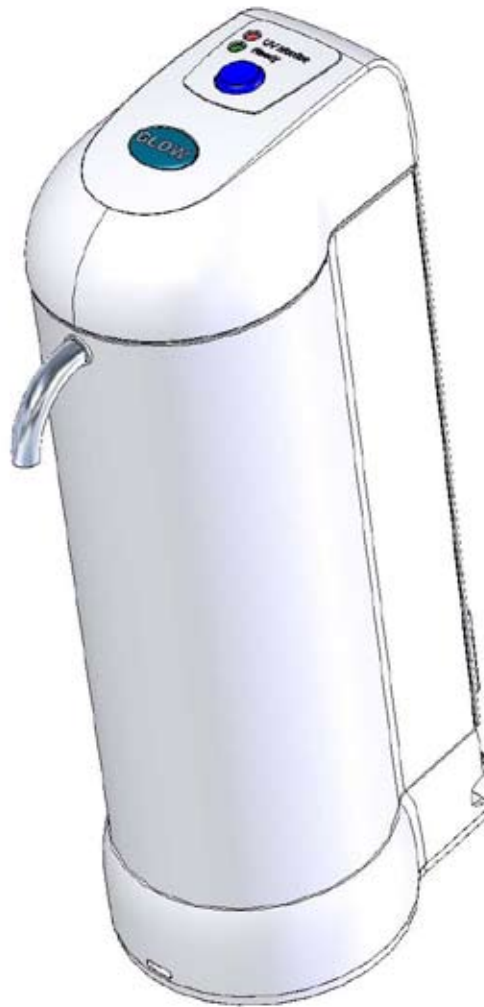

UV400



Introduction

Congratulations on your new water purifier GLOW UV400!

The UV400 is designed for producing the water for drinking and cooking of a normal household.

The water source must either be from the municipal water system or well, aimed for personal consumption.

It is designed to give you plenty of clean water in years to come, if correctly used and maintained.

Therefore, it is of the utmost importance to read the User Manual thoroughly and must be kept in a safe place for future reference.

Make sure that the User Manual accompanies the UV400 if it is moved, resold or there is a change of owner so the user will always have access to the complete instructions and safety information.

For optimal function it is important that you read the section entitled "Safety Information" on page 5 and that you follow the installation instructions on pages 6-8 in detail.

i We recommend that you refer to page 3 when reading the rest of this User Manual. All bracketed numbers refer to figures 3.1 and 3.2.

Unpacking

Examine the water purifier for any signs of damage and make sure that all accessories are included. See fig. 2.

The following items should be included:

- (A) Water Purifier
- (B) Adapter 12 V
- (C) Wall Bracket
- (D) Diverter Valve with hose
- (E) External Faucet Adapter
- (F) External Thread Insert (and washer)
- (G) Angle Hose Connector 3/4" nut and washer
- (H) User Manual

Should you discover any damage, faults, or anything missing, you should notify your dealer immediately.

 **Keep packaging material out of children's reach.**



Guide to use the Manual

The following symbols will be found in the text to guide you throughout the instructions:

Safety information



Hints and information



Description of the UV400

The UV400 purifies water through filtration and disinfection with UV light.

It requires:

- A water source with pressure
- Voltage, 100 V to 240 V, 50 Hz to 60 Hz. The socket fitting the Adapter 12 V (9).

All features are operated with a one-touch button - **The Blue Button** (1) - guided by the Green Lamp (2) and Red Lamp (3) on the control panel.

Control Panel

- 1 Push Button (The Blue Button)
 - UV Lamp On
 - Water Flow Start and Stop
 - Flush
 - Auto Filling
- 2 Green Lamp (Ready)
- 3 Red Lamp (UV Monitor)

Other Parts

- 4 Top Cover
- 5 Water Pipe (Purifier Water Outlet)
- 6 Body
- 7 Bottom Cover
- 8 Filter Lock
- 9 Adapter 12 V
- 10 DC Plug
- 11 Wall Bracket
- 12 Diverter Valve with hose
- 13 External Faucet Adapter
- 14 External Thread insert (and washer)
- 15 Speedfit Connector with 3/4" nut
- 16 Angle Hose Connector 3/4" nut and washer
- 17 User Manual

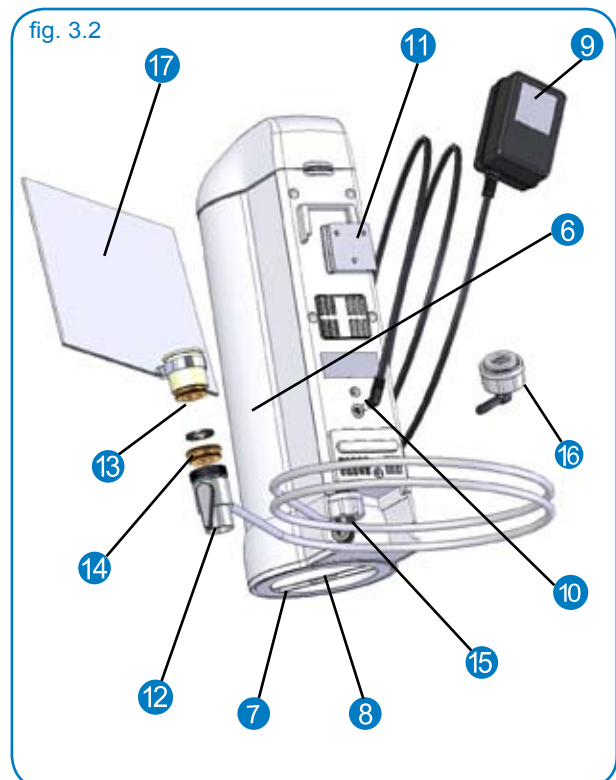
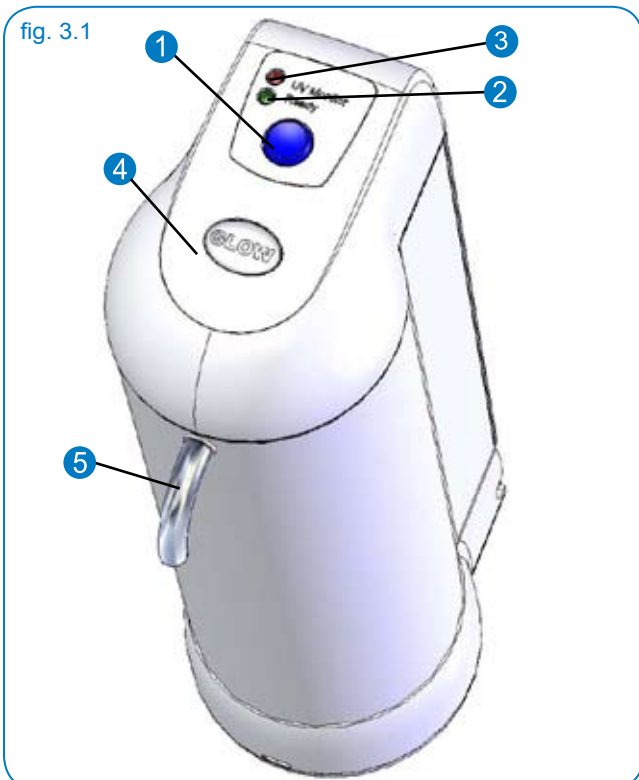

Contents

2	Introduction
3	Description of the UV400
5	Safety Information
6	Installation (Inlet Hose to faucet with Diverter Valve)
7	Installation (Inlet Hose directly to water pipe)
8	Installation (Connecting the Adapter 12 V/Flushing)
9-10	How to use the UV400
11	Maintenance (Replacing the Carbon Block Filter)
12	Maintenance (Replacing the UV Lamp)
13	Maintenance (Replacing the Quartz Sleeve)
14	Maintenance (Cleaning the Quartz Sleeve)
15	Maintenance (Cleaning the Coarse Filter)
16	Regular Care
17	Trouble Shooting: Electrical
18	Trouble Shooting: Water / Consumables
19	Service / Technical Data
20	Company Information

General

The UV400 is an extremely safe water purifier. However, it is important that every user of this product is familiar with its use and safety features.

To prevent mishaps and problems, read the “Safety Information” in this chapter thoroughly and carefully follow the “Installation” instructions on pages 6 to 8.

- The water from the UV400 should only be consumed when the UV400 has been properly maintained and the UV monitor’s Green Lamp (2) is lit. Turn to pages 6 to 15 for Installation and Maintenance.
- Do not change or attempt to modify the UV400. This could result in personal injury and/or damage to property. These eventualities are not covered by any warranty.
- Once a month the connection should be checked for leakage.
- If the UV400 is malfunctioning, disconnect the adapter from the wall socket.
- The water supply to the UV400 must have a normal temperature (between 2 °C and 44 °C) .
If the water supply to the UV400 could be unfit for human consumption, the purified water from the UV400 should be tested and approved for consumption. The tests should be carried out once a year.
- Only use the original 12 V adapter. Use the Adapter 12 V (9) in normal room temperature and avoid direct sunlight.
- The UV400 should not be installed in any location, where the temperature can fall below +2°C (35 °F).
- The UV 400 is compact and heavy for its size especially when filled with water. Thus, it should be handled with care to avoid dropping it that would cause damage.

Installations and service

- Only install the UV400 in an upright vertical position.
- Only use those types of hose and connectors approved for full line water pressure, when connecting the UV400 to its water source.
- Verify that the installation is approved by your insurance company.
- Included hose (12) should be used for the installation of the UV400. Old hoses should be replaced by the new included hose (12).
- Never install an ice-machine or any appliance to the UV400 Water Pipe (5). Use only original spare parts recommended by GLOW.
- Always connect the Adapter 12 V (9) to a socket in a dry location.

Using the UV400

- The UV400 is designed to produce water for drinking and cooking for a normal household.
- The UV400 must never be used without the Carbon Block Filter, except during the descaling procedure.
- Never block the Water Pipe (5) of the UV400.
- Never connect a hose to the Water Pipe since it can accidentally get folded and cause damage to the UV400. This kind of damage is not covered by any warranty.
- The UV400 is not intended for use by persons (including children) with reduced physical, sensory or mental capabilities, or lack of experience and knowledge, unless they have been given supervision or instruction concerning use of the UV400 by a person responsible for their safety. Children should be supervised to ensure that they do not play with the UV400.

Installation

Please read the “Safety Information” on page 5 before the installation of the UV400.

The UV400 must always be installed for usage in the vertical upright position. It can be used as a table top appliance and/or mounted on the wall, whatever is most practical. The UV400 can either be connected to a faucet or to a water pipe.

Your dealer can help you with the most suitable installation and provide you with needed accessories.

Installation of Inlet Hose

1. Choose a dry area near the kitchen sink.
2. Decide what type of installation and water connection.
 - Wall mounted (fig. 6.1) with Wall Bracket (11) and/or table top? (fig. 6.2)
 - Type of water connection?
 - Alt A. to faucet with Diverter Valve (fig. 6.2)
 - Alt B. to water pipe (fig. 7.4).
 - The UV400 should not be installed more than 1.8 meters away from an electrical outlet (within reach of the connection of the DC Adapter 12V).

fig. 6.1



Alternative A: Installation to faucet with Diverter Valve (fig. 6.2)

- Before installation, always remove strainer from the tap if applicable (fig. 6.3)
- Check if your faucet matches any of the installation alternatives below. If not, contact your dealer for further advice and recommendations.
 - Alternative A1: Faucet with outer thread 22 mm (fig. 6.4)
 - Alternative A2: Faucet with inner thread (fig. 6.5)
 - Alternative A3: Faucet with round pipe
 - with Rubber Insert (6.3) $\varnothing \sim 16\text{mm}$ (fig. 6.6)
 - without Rubber Insert (6.4) $\varnothing \sim 20\text{mm}$ (fig. 6.7)
- Connect the Diverter Valve with hose to the faucet according to the matching Alternative.
- For Alternative A3, use a screw driver to tighten the metal ring around the rubber.

fig. 6.2



fig. 6.3

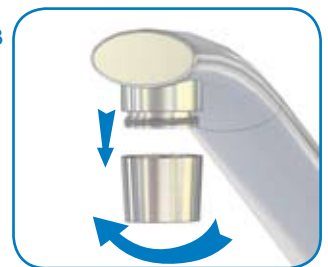

fig. 6.4



fig. 6.5



fig. 6.6



fig. 6.7



3. Connection of the Inlet Hose.

- Place the water purifier where it will be used.
- Determine the right length of the Inlet Hose and place it there where it does not get in the way.
- Cut the Inlet Hose to its proper length (fig. 7.1).
- See to it that there are no folds in order for the water to flow freely.
- Insert the Inlet Hose to the Speedfit Connector (15) (fig. 7.2).
- Make sure it is fully inserted and locked when it is pulled.

fig. 7.1



4. Turn on the water supply

- Open the valve of the faucet.
- Turn the handle of the Diverter Valve clockwise to horizontal position (fig. 7.3).
- Check for any leakage.

fig. 7.2



5. Turn off the water supply.

- Close the Valve of the faucet.
- Check for any leakage.
- Turn the handle of the Diverter Valve counter clockwise to vertical position.

fig. 7.3

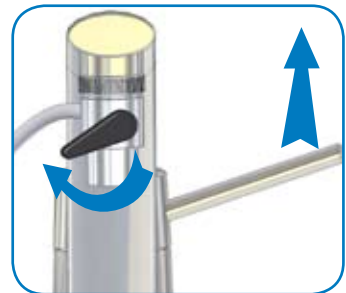

Alternative B: Installation to water pipe (fig. 7.4)

Since the GLOW UV400 works with a Solenoid Valve, it can be directly installed to the water pipe. This is a more permanent installation and GLOW UV400's automatic features can be enjoyed to its full capacity.

It is recommended to contact your authorized dealer for assistance for this type of installation.

fig. 7.4

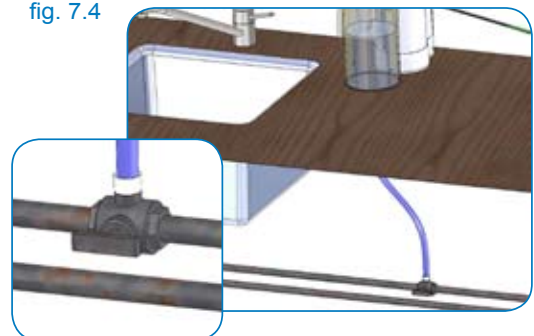

i Disconnection of the hose (fig. 7.5)

In case you need to disconnect the hose from the installed water purifier, do the following:

- Make sure that the water is OFF (no water pressure in the hose).
- Push the locking ring (highlighted) against the housing (arrow A), at the same time pull out the hose (arrow B).

fig. 7.5

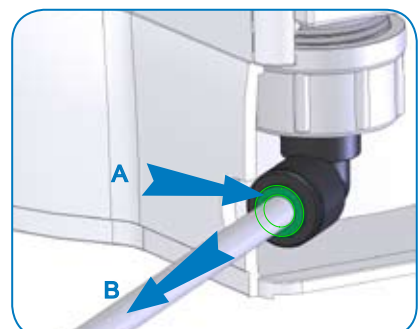

Connecting the Adapter 12 V

1. Connect the DC Plug (10) to the UV400 (fig. 8.1).
2. Connect the Adapter 12 V (9) to the electrical socket in a dry location.

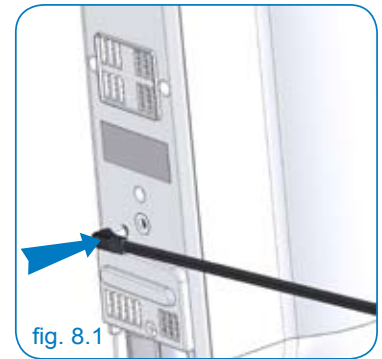

Flushing Procedure

The UV400 should be flushed:

- after installation of the UV400
- after replacement of filter
- Descaling Procedure

Never consume the flushed water. During the flushing the UV Lamp is not lighted which means that the water does not get sterilized.

1. Disconnect the DC Plug (fig. 8.2).
2. Push The Blue Button (1) and keep it pressed (fig.8.3) at the same time as the DC Plug (fig. 8.4) is reconnected.
3. After a short time the Solenoid Valve will open and water will enter the UV400.
4. Keep The Blue Button pressed down during the entire flushing procedure (fig. 8.5).
5. Release The Blue Button to stop the flushing.

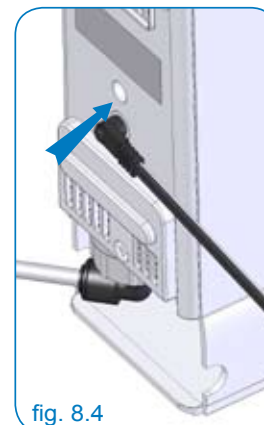

The UV400 is easy to use. Just press The Blue Button (1). Thanks to modern and advanced electronics, all features are controlled by the Blue Button with the guidance of the Green (2) and Red (3) Lamp. The first “push” of the Blue Button (1) will activate the UV lamp inside the UV400. The Green Lamp will blink for about 20

seconds before you can draw water. During this period the UV lamp is preheated for optimum disinfection. After this the Blue Button is used for opening and closing the water flow. The UV400 will automatically shut off when it is not in use (the solenoid valve is not opened) for approximately 30 seconds.

Before operating the UV400

1. Be sure that the UV400 is connected to its water source and that the water pressure is on.
2. Verify that the UV400 is connected to the DC Plug (10) and that the Adapter 12 V (9) is connected to the wall socket.

Normal Operation of UV400

Turn-on the UV Lamp

1. Push The Blue Button (1) once to TURN-ON the UV lamp (fig.9.1).
 - The Green Lamp (2) should be blinking slowly for approximately 20 seconds the first time (*5 seconds for following usage, as long as the voltage supply is not disconnected*). (fig. 9.2)
 - When the Green Lamp stops blinking and stays lit, purified water is ready to be drawn from the UV400.

Draw and Stop Purified Water

2. Push the Blue Button one more time for DRAWING water (fig. 9.3).
 - The Green Lamp should now be blinking rapidly that the solenoid valve is open.
3. Push the Blue Button, one more time for STOPPING the flow of water.
 - The Green Lamp should stay lit.
4. Sequence 2 and 3 are repeated.

i Reminder: The Green Lamp and the UV light will shut off automatically after 30 seconds if not in use.

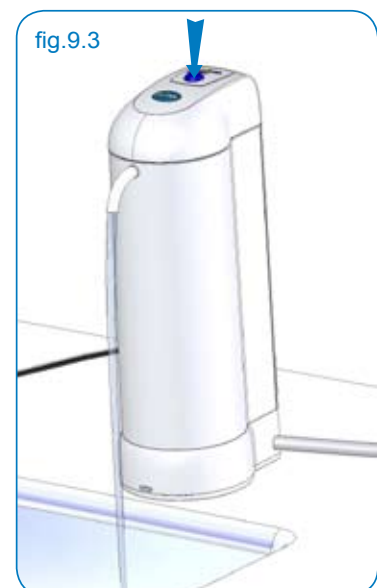
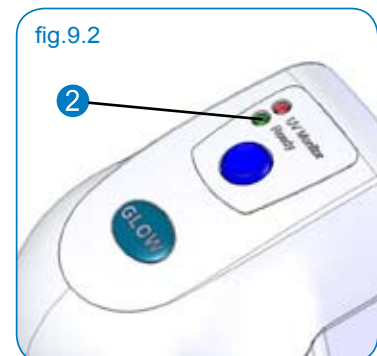
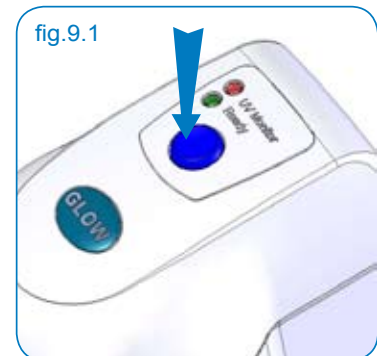

How to use the UV 400

With the Auto Filling feature you can draw the desired amount of water in multiples of 0.5 l (amount of water

during 30 seconds.) This is very practical since you can do other things while filling up your pitcher or container.

i Before using the Auto Filling function the UV400 should be in ready mode (UV Lamp should be lit).

Auto Filling

1. Push the Blue Button (1) and keep it down while observing the following:
 - That the Green Lamp (2) blinks slowly.
 - And is constantly lit (fig. 10.1).
2. Release The Blue Button when the desired number of flashes is reached. Each flash corresponds to 0.5 l (> 2 bar and new filters).

Examples:

3 flashes correspond to $3 \times 0.5 \text{ l} = 1.5 \text{ l}$

5 flashes correspond to $5 \times 0.5 \text{ l} = 2.5 \text{ l}$

i Make sure that your container is big enough for the desired amount of water.

! Never leave the room when drawing water from the UV400. Always make sure that the water really stops before the container overflows.

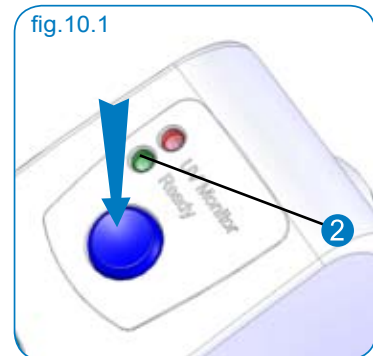

Replacing the Carbon Block Filter

The Carbon Block Filter has to be replaced when:

- The water flow has been reduced to about half of its full capacity.
- It has been in use for 6 months.

1. Disconnect the DC Plug (10) from the water purifier.
2. Place the UV400 near a water outlet (normally the kitchen sink) and be prepared for water to come out.
3. Open the **Bottom Cover** (7) by turning it counter clockwise (fig. 11.1) and pull it out together with the attached Carbon Block Filter (fig. 11.2).
4. Be prepared for excess/left-over water to come out.
5. Clean the inside of the Filter Chamber with a small brush and rinse with clean water.
6. Press the lock located at the center of the Bottom Cover towards the direction as shown in fig. 11.3.
7. Detach the old Carbon Block Filter and insert the NEW Carbon Block Filter into the Bottom Cover.

Make sure that the rubber seal is properly fitted as shown in fig. 11.4.

Lubricate the rubber seal with any vegetable oil for easier fitting when tightening the Bottom Cover (fig. 11.6).

8. Push the Filter Lock (8) back to the center of the Bottom Cover (fig. 11.5).
9. Insert the Bottom Cover with the NEW attached Carbon Block Filter and tighten the Bottom Cover clockwise (fig. 11.6).
9. Flush the UV400 for 5 minutes before using it again.

See "Flushing Procedure" on page 8.

fig.11.1



fig.11.2



fig.11.3



fig.11.4



fig.11.5



fig.11.6



Replacing the UV Lamp

It is rare that the UV Lamp has to be replaced, since the UV400 has a shut off timer. However, certain conditions might cause damage or break the UV Lamp.

Hold the end of the UV Lamp (metal cap) when connecting and disconnecting the terminal(s).

Never pull the wire(s) for detaching the terminals of the UV Lamp.

Disconnecting UV Lamp

1. Disconnect the DC supply to the UV400.
2. Open the Top Cover with a coin by twisting it (fig. 12.1).
3. Disconnect the terminal (fig. 12.2) by pulling it up at the same time holding the end tip (metal cap) of the UV Lamp.
4. Pull up the UV Lamp carefully (fig. 12.3).
5. Disconnect the bottom-end of the terminal (fig. 12.4).

Installing UV Lamp

6. First connect the bottom-end terminal (with white wires) (fig. 12.5) by fitting the terminal to the two pins of the UV Lamp.
7. Insert the UV Lamp with the connected bottom-end terminal into the Quartz Sleeve (fig. 12.6).
8. See to it that the UV Lamp is fully inserted.
9. Reconnect the top terminal (with blue wires) to the two pins of the UV Lamp (fig. 12.7).
10. Refit the Top Cover and push it down until it snaps in place (fig 12.8). Make sure that no cables are squeezed.
11. Re-connect the DC supply.

 Only use GLOW's original UV Lamp to ensure proper disinfection and function.

 A different type of UV Lamp can harm the electronics, which would not be covered by the warranty.

 Do not touch the glass of the UV Lamp since fingerprints can reduce UV transmittance.

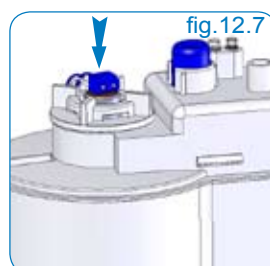
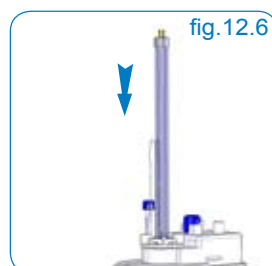
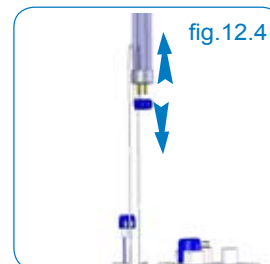
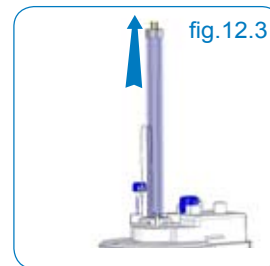
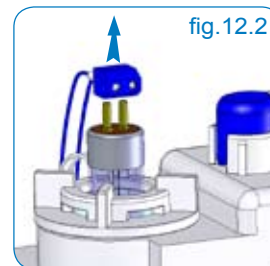
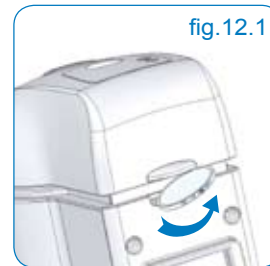

Replacing the Quartz Sleeve

Before replacing the Quartz Sleeve, disconnect and remove the UV lamp. Refer to fig. 12.3 in “Replacing the UV Lamp” on page 12.

1. Unscrew the Quartz Sleeve Holder (fig. 13.1).
2. Pull out the Old Quartz Sleeve together with the O-ring (fig. 13.2).
3. Insert the new Quartz Sleeve with the O-ring (fig. 13.3).
4. Fit and screw the Quartz Sleeve Holder and tighten the Silicon O-ring hard (fig. 13.3).

If the Quartz Glass is broken, replace it immediately.

 Make sure that there are no remaining shards of glass from the Quartz Sleeve in the UV chamber. Broken Quartz Sleeve should be kept away from children’s reach and disposed of appropriately.

fig.13.1

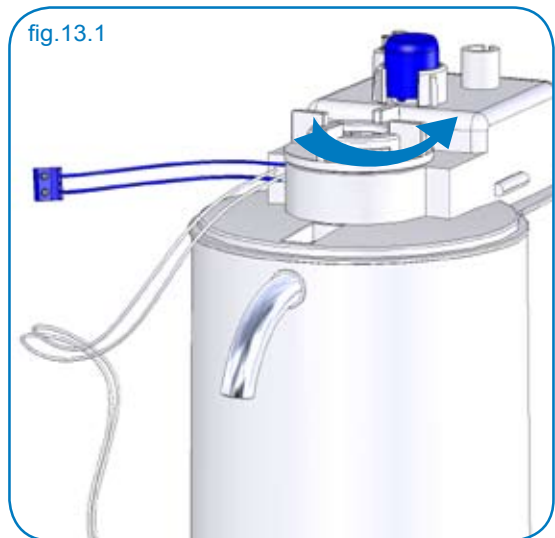

fig.13.2

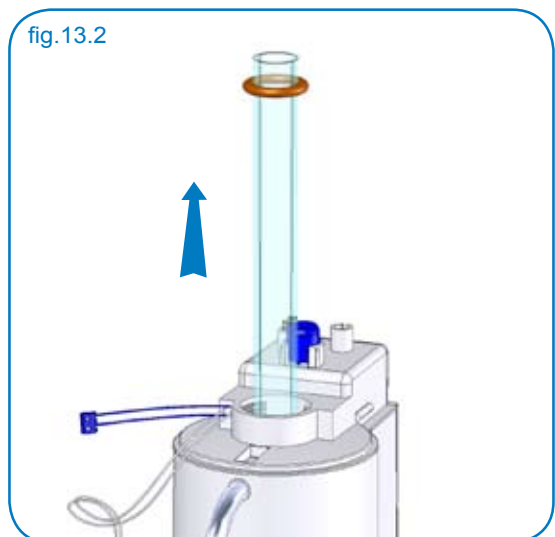
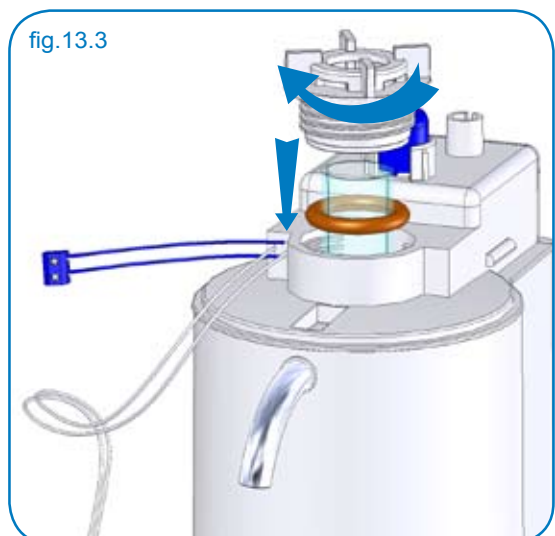

fig.13.3



Cleaning (Descaling) the Quartz Sleeve

1. Disconnect the DC plug (10).
2. Remove the UV Lamp (see page 12). Follow instructions 1 to 5.
3. Unscrew the Quartz Sleeve Holder (fig. 14.1).
4. Pull out the Quartz Sleeve together with the Silicon O-ring (fig. 14.2). Be careful not to drop or damage the Quartz Sleeve.
5. Prepare a solution of water and vinegar for cleaning and descaling of the Quartz Sleeve.
6. Wet a clean cotton cloth with the water and vinegar solution.
7. Gently rub the **outside** surface of the Quartz Sleeve with the wet cloth cleaning it thoroughly (fig. 14.3).



Make sure that the inside of the Quartz Sleeve **does not** get wet. This could later short-cut the UV Lamp.



Avoid touching the Quartz Sleeve directly with the fingers below the Silicon O-ring.

8. Insert the newly-cleansed Quartz Sleeve Holder and tighten the Quartz Sleeve holder (fig. 14.4).
9. Insert and re-connect the UV Lamp, (see instructions 6 to 11 on page 12).

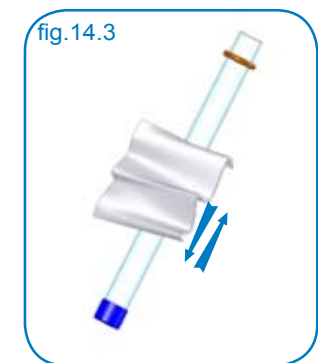
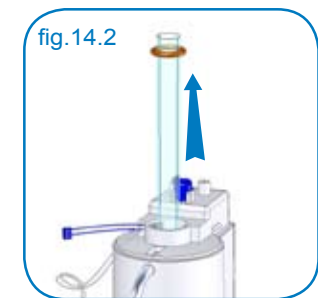

Cleaning the Coarse Filter

If the water supply contains a lot of sediments the Coarse Filter can get saturated.

Before Cleaning the Coarse filter

1. Disconnect the DC Plug (10) of the UV400.
2. Close the tap/valve of the water supply to the UV400.

Cleaning the Coarse Filter

3. Put the UV400 carefully on the side.
4. Unscrew the hose connector from the Solenoid Valve (fig 15.1).
5. Grip the Coarse Filter with a small plunger and pull it out of the Solenoid Valve (fig. 15.2).
6. Clean the Coarse filter with a brush and water (fig. 15.3) and push it back into the solenoid valve with a plier (fig. 15.4).
7. Refit the water inlet hose.
8. Open the tap to the water supply and verify that the water inlet connection does not leak.
9. Connect the DC Plug to the UV400.

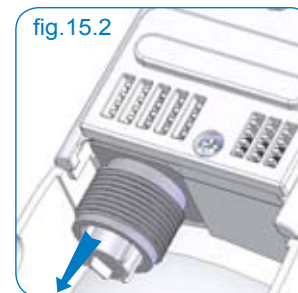



Things to Remember

Listed are the things you need to remember for the regular care and maintenance of your UV400.

- Check the function of the Green Lamp (2) every time the UV400 is in use.
- Never leave the room with the Green Lamp flashing, which means the UV400 will NOT automatically shut off since the solenoid valve is open.
- Check weekly that all connections to the UV400 are properly sealed.
- Always unplug the UV400 if it is not used for a long time.
- Always carry out the descaling procedure regularly.
- If the water supply has been classified as unfit for drinking, the water from the UV400 should be tested frequently.
- Avoid installing the UV400 in a hot or cold area or where it is exposed to direct sunlight.
- Never connect an equipment or a hose to the water outlet of the UV400.

 The Carbon Block Filter needs to be replaced when the water flow has been reduced to half compared to when the filter was new, or every 6 months.

 For an immediate shut down of the UV400, simply disconnect or unplug the adapter.

 Never pour water over the water purifier or dip it in water.

 Never let the Adapter 12V get wet. Never clean the adapter with a wet or damp cloth.

Frequency of descaling

Calcium Ca ²⁺ and Magnesium Mg ²⁺ mg/l	Water hardness °d (German water hardness standard)	Period between every descaling procedure
- 50	- 7	6 months
50 - 100	7 - 14	3 months
100 - 140	14 - 20	1 month



The UV400 has several built-in safety features indicated by the Red and Green Lamp on the Control Panel.

Symptoms/Warnings	Check
Red Lamp (UV Monitor) (3) shines steadily	<p>UV light and disinfection assurance</p> <ul style="list-style-type: none"> • If the UV Lamp is damaged, replace the UV Lamp * • If the UV Lamp is not properly connected Assure that the UV Lamp terminals are properly fitted to the pins of the UV Lamp • If any wires have gotten detached from the UV Lamp terminal(s)
Red Lamp (UV Monitor) and Green Lamp (Ready) are flashing together.	<p>Over Current Protection</p> <ul style="list-style-type: none"> • The room and water are too cold, below 4 degrees Avoid cold water or areas • UV Lamp terminal electrically shortcut by water Check if the end of the UV is wet Check if the Quartz Glass Sleeve has water inside
The Lamp does not light up, nothing happens	<ul style="list-style-type: none"> • You press the Blue Button too quickly • The unit is not properly connected to the electrical source • Incorrect Adapter 12 V
UV Monitor Red Lamp and Ready Green Lamp are flashing	<ul style="list-style-type: none"> • Incorrect voltage You might use wrong 12 V adaptor

* Only use original spare parts and consumables.

Trouble Shooting: Water



If the water which comes out of the unit is of poor quality or if the unit is leaking

Symptoms/Warnings	Check
If no, or only a little amount of water comes out of the UV400, despite the Green Lamp flashing (Solenoid Valve being open).	<ul style="list-style-type: none"> • Is the water on and the pressure high enough? • Is the Carbon Block Filter old and/or saturated? If so replace filter. • Is the Coarse Filter clogged? Clean it.
Water leaks from the UV400	<ul style="list-style-type: none"> • Is the Bottom Cover tightened? • Is the Sleeve Holder tightened? • Is the inlet hose to the purifier connected properly.
Bad smelling water	<ul style="list-style-type: none"> • Has the unit not been used for a long period? Run the UV400 for at least 5 minutes. Dispose the water. • Let the UV400 run for about 10 minutes before initial use. • Is the Carbon Block Filter old? The activated carbon effect might have been depleted.
The UV400 drips	<ul style="list-style-type: none"> • After a new filter is installed, the UV400 may drip before all air has disappeared. This normally disappears after a few minutes of use. • No Carbon Block Filter is used. Install a new one. • Old Carbon Block Filter is used. Replace it.

Consumables / Spare parts

If the UV400 does not work properly, we recommend that you start to use the Trouble Shooting (see page 17 and page 18), before calling for service.

We also recommend that you always keep an extra Carbon Block Filter available if it needs to be replaced.

Contact your authorised dealer for consumables and spare parts.

The UV Lamp and Quartz Sleeve rarely need to be replaced. However, certain conditions might damage them.

The filter is the part which normally has to be replaced regularly for proper function.

Spare Parts:

Carbon Block Filter



UV Lamp



Quartz Sleeve

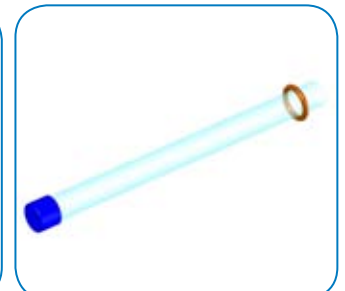

Service

Before calling service, take down notes of the problem of your UV400.

For easy and faster support note down the product no. and serial no.

For service and spare parts, please contact your authorized dealer.

Technical Data

Power Supply to 12 V Adapter	100 V to 240 V, 50 Hz to 60 Hz
Power Supply to Water Purifier (Only use original adapter)	12 V DC, stabilized
Power Consumption with Adapter 12 V included: when pouring water:	Max 20 W
Water line pressure:	0.5 bar – 8 bar
Weight (without water):	3.0 Kg
Water Flow :	approximately 2.7 litres per minute > 2 bar
Dimensions:	h36 x w12 x d19 cm
Water supply temperature:	Minimum 2 °C Maximum 44 °C
Recommended water source for normal filter usage	Turbidity < 1 FNU Chlorine > 4 mg/l Organic substances < 1 mg/l

Dealer:

The UV400 is developed and marketed by Glow AB.

Glow AB
Kopparbergsvägen 6
SE- 722 13
Sweden



www.glowinternational.net

Made in the E.U.